

HEATLESS DESICCANT AIR DRYERS

HCX, HCL & HCT SERIES: 40-5400 SCFM (68-9175 NM³/H)
Delivering clean, dry compressed air to industry

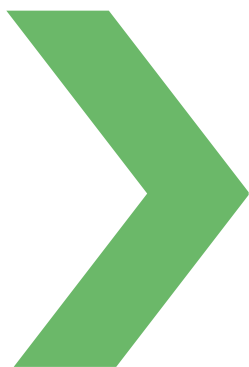

INDUSTRY LEADING DESIGN

HEATLESS DESICCANT AIR DRYERS

Since 1963, compressed air users around the world have relied on Deltech to provide innovative compressed air treatment solutions for critical applications.

As an SPX FLOW brand, Deltech is dedicated to ongoing advancements in air treatment technology, providing industry and critical applications clean, dry compressed air.

Clean, Dry Compressed Air Results In Significantly Lower Operating Costs

Solid contaminants such as dirt and dust, as well as gaseous contaminants including oil vapor and water vapor enter the compressor intake along with the ambient air. During the compression process, additional contaminants are added to the air stream such as oil aerosols and compressor wear particles. If left untreated, the contaminants travel downstream adversely affecting the air distribution system, pneumatic processes and finished product.

The HCX, HCL & HCT Series

Deltech's HC series heatless desiccant dryers are designed to efficiently dehydrate compressed air to dew points as low as ISO 8573-1 Quality Class 1 (-94°F/-70°C)

Industries such as pharmaceutical manufacturing, laboratories, hospitals, microelectronics, food packaging, paper, glass, and powder painting with low dew point requirements, utilize heatless desiccant air dryers.



Industry Leading Performance & Design

- HC series heatless desiccant air dryers are available with three application control systems designed to meet the needs of specific industrial applications for economy, performance, and energy savings
- Comprehensive offering: Eighteen models 40 to 5400 scfm (68 to 9175 nm³/h)
- Delivers stable ISO 8573-1 Quality Class 1 (-94°F/-70°C) to Class 4 (+38°F/+4°C) outlet pressure dew points
- Single-phase, alternating current input power connection of 190-305 VAC / 50-60 Hz; pre-wired with an AC to 12 VDC external power supply
- Large diameter piping promotes low pressure drop and lower cost of operation
- Optimally sized desiccant beds ensure 4.8 seconds of contact time for complete drying
- Cleanable, stainless steel flow diffusers eliminate channeling through the bed
- Up-flow drying allows water and heavy contaminants to drop out of the air stream
- Separate fill and drain ports for ease of desiccant replacement



OPTIONAL
5 YEAR
WARRANTY

HCX, HCL, HCT Series Extended Warranty

PROTECT YOUR EQUIPMENT

- As an extra measure of protection, Deltech will provide additional coverage beyond the standard 1-year warranty.
- Purchase and register a HCX, HCL or HCT dryer with filtration package to qualify for an extended warranty up to 5 years.
- Warranty will be extended yearly through the purchase and installation of a qualifying annual maintenance kit.
- Extended warranty covers up to 4 years additional protection, parts and labor, a total of 5 years. Reference the General Terms, Warranty Policies & Procedures Handbook for more details.

HCX SERIES

Deltech's HCX Series With Patented SensaTherm Automatically Matches Purge Air to Plant Air Demand

SensaTherm ensures maximum performance as the saved energy goes right to your bottom line.

When operating at reduced capacity, the on-line drying tower remains active longer, until its full drying capacity is utilized. Desiccant bed temperature changes are constantly monitored within each tower to precisely manage drying times and reduce purge air consumption.

SensaTherm measures the increase in desiccant bed temperature (heat of adsorption) during the drying stage and the decrease in desiccant bed temperature (heat of desorption) during the regeneration stage. These temperature changes are accurate indicators of the moisture load on the dryer. This data is interpreted by microprocessor based controls to determine how long a tower stays on-line during the drying stage.

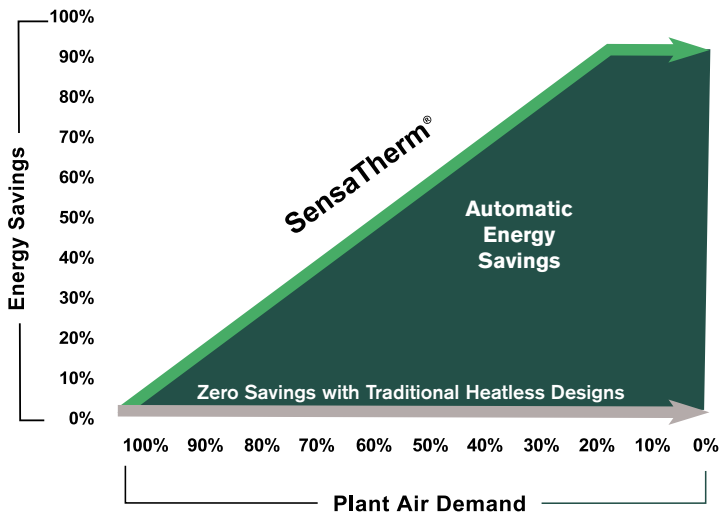

Maximize your return-on-investment automatically. HCX Series with SensaTherm® delivers energy savings in direct proportion to load variations from your plant air demands, making it the Auditor's Choice.

HCX SERIES CONTROLLER FEATURES

Featuring a 7" LCD, Capacitive Color Touchscreen for at-a Glance Monitoring and Operating Status

- The solid-state controls are housed in a polycarbonate, NEMA Class 4X, IP66 rated electrical enclosure
- Certified for quality and safety to CSA C22.2 No.0-10, C22.2 No.14-18 & UL 508
- High visibility, color-coded steps facilitates system monitoring
- Hybrid gauges display (digital/analog) for rapid value and intuitive status

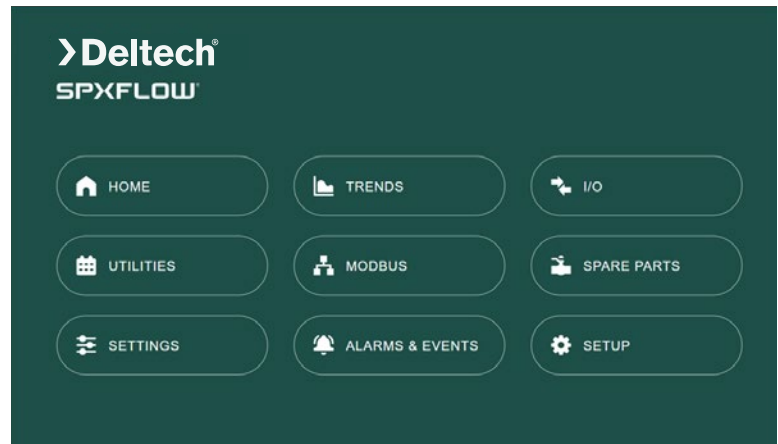

Communications to Pace With IOT Technology, for Connecting and Exchanging Data with Devices and Systems

- Easily communicate with user's DCS systems utilizing Modbus TCP/IP communication via one of two available Ethernet ports
- Access the web interface via Ethernet with a dynamic or static IP address, selectable by the user
- Standby or Offline status initiated or exited remotely through Modbus access
- Serial RS-485 for point-to-point communication of electrical devices

Fully-Featured Controls for Troubleshooting, Performance Trending, and Fault Alarms

- Up to 30 days of information Data logging, recorded to internal memory or USB drive (events, states, inputs, alarms, warnings)
- A trends screen allows the user to view temperature and pressure values plotted over time
- Service reminders indicate time to perform preventive maintenance on filters, drains, valves, and desiccant
- On board spare parts list and instruction manual for ease of reference

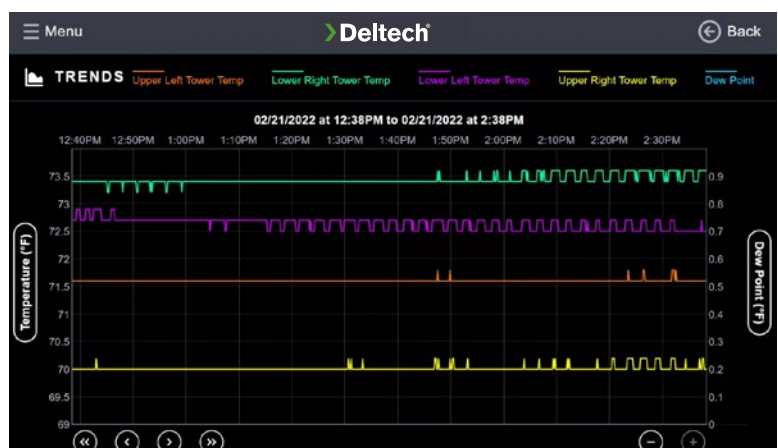

HCL SERIES

HCL Series provides user selectable energy savings with tailored drying cycles designed to match your peak air demands

Controller Features

- Choice of four fixed cycle operating modes corresponding to ISO 8573-1 Air Quality Classes
- Choice of eight Purge Economizer Energy Savings settings
- Switches for On/Off, Alarm and Service reminder reset
- Operational LED lights for power-on, tower status, valve status, and tower pressure
- Alarm LED for valve switching failure
- RS-232 communications port is standard
- Service reminder LED lights for filters and drains, valves and desiccant

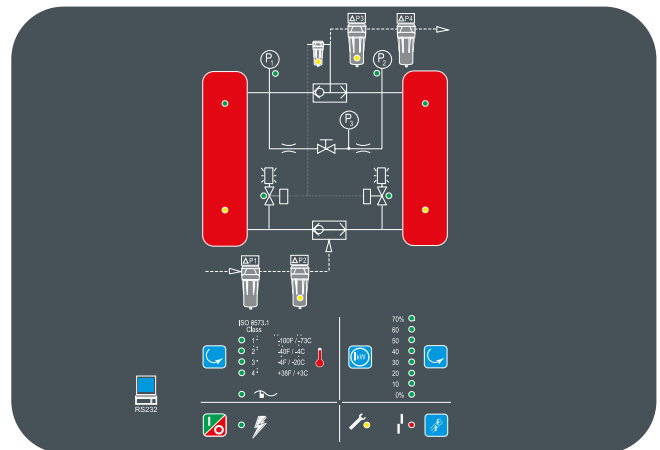

Reducing the amount of time the dryer spends purging in the regeneration cycle can save energy.

Eight settings (0% to 70% in 10% increments) are furnished for users to lower the purge to match reduced air loads on the dryer. In addition, this state-of-the-art controller offers four pressure dew point settings to further tune your savings and adapt the system to your environment.



Purge Economizer lets you align your purge costs with your air demands to optimize your return-on-investment. Tailor HCL Series dryers to take full advantage of air system efficiency improvements driven by air audit strategies.



HCT SERIES

Deltech's HCT Series is Engineered to Address the Need for Performance and Value.

The traditional HCT design uses a simple timer to alternate the flow between the two towers filled with premium grade desiccant. These are designed to deliver maximum value to applications that operate at-or-near full capacity.

Automatic time controlled bed regeneration cycles offer consistent performance and economy of purchase. While the on-line tower is drying the air stream, the off-line tower purges a fixed amount of compressed air to dry the bed and prepares it for the next drying cycle.

- One fixed cycle mode corresponding to ISO 8573-1 Air Quality Class 2 (-40°F /-40°C)

Controller Features

Control Panel overlay with LED's indicating:

- Power On
- Left Tower Drying
- Right Tower Drying

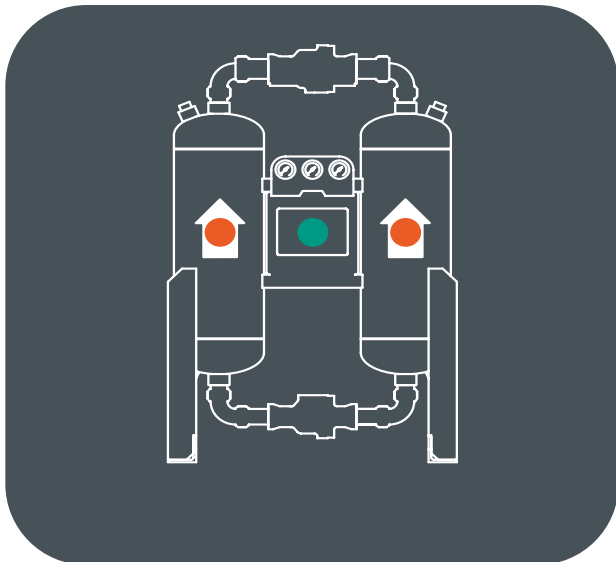

OPERATING PRINCIPALS

Phase 1

Moisture laden, filtered compressed air enters the pressurized on-line desiccant-filled drying Tower 1 through the AccuShift™ valve (A)

Phase 2

Up-flow drying enables the desiccant to strip the air stream of moisture. Clean, dry compressed air exits through AccuShift™ valve (B) to feed the air system

Phase 3

When in regeneration mode, Tower 2 depressurizes to atmosphere through the muffler (C) when the valve (D) opens

Phase 4

A portion of dry compressed air (purge air) is diverted before exiting (B) and passes through off-line Tower 2 and exits at valve (D) to desorb the moisture from the desiccant. Once desorbed, valve (D) closes and Tower 2 is repressurized

Phase 5

At tower shift-over, valve (E) will open, causing AccuShift™ Valves (A & B) to shift

Phase 6

Tower 2 will be placed on-line to dry the bed. Operations will switch and Tower 1 will be regenerated

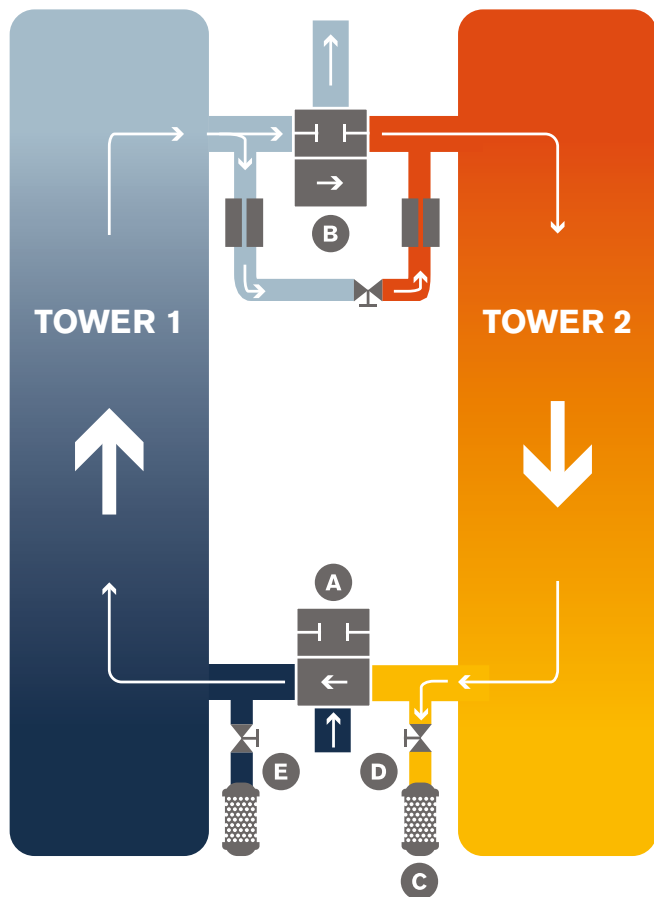

Simple Operation

The AccuShift™ shuttle valve is free to move back and forth closing the inlet having the lower pressure and giving preference to the inlet with the high pressure

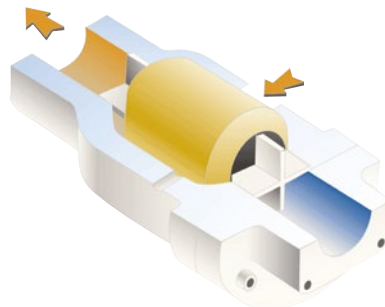

INTEGRATED FILTRATION

Base Filtration Package (Pre-filter and After-filter):

H3 Series Pre-filter:

Protect the valves and desiccant bed from oil contamination

- Removes 99.99% of oil aerosol content to 0.01 mg/m³
- ISO Quality Class remaining oil - 1

P3 Series After-Filter:

Protects down-stream components from desiccant dust

- Remove 99.999% of solids 1.0 micron and larger
- ISO Quality Class solids - 2

Advanced Filtration Package (Dual Pre-filter and single After-filter):

P3 Series Pre-Filter:

Removes solids, protects the high-performance oil removal filter

- Remove 99.999% of solids 1.0 micron and larger
- ISO Quality Class solids - 2

H3 Series Pre-filter:

Protect the valves and desiccant bed from oil contamination

- Removes 99.99% oil aerosol content to 0.01 mg/m³
- ISO Quality Class remaining oil - 1

P3 Series After-Filter:

Protects down-stream components from desiccant dust

- Remove 99.999% of solids 1.0 micron and larger
- ISO Quality Class solids - 2



**Protect Your Investment and
Extend the Warranty with
Factory Mounted 300 Series
Filtration Packages**



SPECIFICATIONS

MODEL	INLET FLOW @ 100 PSI (6.7 BAR)		DIMENSIONS						INLET / OUTLET CONNECTIONS ¹	WEIGHT LBS
	SCFM	NM ³ /H	IN	H MM	IN	W MM	IN	D MM		
HCX/HCL/HCT-40	40	68	46	1,168	32	813	32	813	1" NPT	365
HCX/HCL/HCT-60	60	102	61	1,549	32	813	32	813	1" NPT	445
HCX/HCL/HCT-90	90	153	78	1,981	32	813	32	813	1" NPT	575
HCX/HCL/HCT-115	115	195	54	1,372	44	1,118	38	965	1" NPT	685
HCX/HCL/HCT-165	165	280	54	1,372	44	1,118	38	965	1" NPT	685
HCX/HCL/HCT-260	260	442	72	1,829	49	1,245	38	965	2" NPT	1,010
HCX/HCL/HCT-370	370	629	63	1,600	55	1,397	38	965	2" NPT	1,215
HCX/HCL/HCT-450	450	765	71	1,803	55	1,397	38	965	2" NPT	1,350
HCX/HCL/HCT-590	590	1,002	101	2,565	50	1,270	53	1,346	2" NPT	1,473
HCX/HCL/HCT-750	750	1,274	109	2,769	51	1,295	48	1,219	3" ANSI FLG.	2,134
HCX/HCL/HCT-930	930	1,580	113	2,870	56	1,422	56	1,422	3" ANSI FLG.	2,414
HCX/HCL/HCT-1130	1,130	1,920	113	2,870	59	1,499	56	1,422	3" ANSI FLG.	2,875
HCX/HCL/HCT-1350	1,350	2,294	118	2,997	60	1,524	56	1,422	3" ANSI FLG.	3,722
HCX/HCL/HCT-1550	1,550	2,634	113	2,870	66	1,676	56	1,422	3" ANSI FLG.	4,167
HCX/HCL/HCT-2100	2,100	3,568	116	2,946	73	1,854	56	1,422	4" ANSI FLG.	4,417
HCX/HCL/HCT-3000	3,000	5,097	122	3,099	78	1,981	65	1,651	4" ANSI FLG.	9,010
HCX/HCL/HCT-4100 ²	4,100	6,966	124	3,150	93	2,362	88	2,235	6" ANSI FLG.	9,900
HCX/HCL/HCT-5400 ²	5,400	9,175	126	3,200	102	2,591	92	2,337	6" ANSI FLG.	12,000

Maximum Working Pressure: 150 psi (10.5 bar) standard; 250 psi (17.6 bar) optional. Units with higher Maximum Working Pressures are available.

Minimum Operating Pressure: 150 psi (10.5 bar) service - 60 psi (4.1 bar); 250 psi (17.6 bar) service - 120 psi (8.4 bar)

Maximum Inlet Air Temperature: 140°F (60°C)

Maximum Ambient Air Temperature: 120°F (49°C)

Pressure Drop at Rated Flow: Less than 5 psi (0.35 bar)

Available Voltages: HCT - 100-120V/1ph/50-60Hz, HCL/HCX - 100-240V/1ph/50-60Hz and 12-24 VDC

Dimensions and weights are for reference only. Request certified drawings for construction purposes.

1 BSP and DIN flanges available

2 Supplied with premium quality butterfly switching valves

ISO 8573-1 Air Quality Standards

Deltech heatless dryer designs allow optimized performance meeting the following ISO 8573-1 Quality Classes of Air.

		ISO 8573-1 QUALITY CLASS			
		1	2	3	4
DEW POINT	°F	-100°	-40°	-4°	38°
	°C	-73°	-40°	-20°	3°
REMAINING MOISTURE	ppm/w	0.12	10	81	610
	mg/m ³	0.15	12	97	730
HCX SERIES		4 min. fixed	Demand or 10 min. fixed	Demand or 16 min. fixed	-
HCL SERIES		4 min. fixed	10 min. fixed	16 min. fixed	24 min fixed
HCT SERIES		-	10 min. fixed	-	-

Correction Factor

Inlet flow capacities are established in accordance with ISO 7183 (A2):

Inlet air pressure 100 psi (6.7 bar), inlet temperature 100°F (38°C).

To determine the dryer's maximum flow capacity at pressures other than 100 psig, multiply the dryers rated flow from the Specifications chart by the corresponding multiplier.

PRESSURE		MULTIPLIER
PSI	BAR	
60	4.13	0.65
70	4.83	0.74
80	5.52	0.83
90	6.21	0.91
100	6.89	1.00
110	7.58	1.04
120	8.27	1.08
130	8.96	1.12
140	9.65	1.16
150	10.34	1.20
175	12.06	1.29
200	13.78	1.37
225	15.51	1.45
250	17.24	1.52

EXAMPLE:

System pressure: 120 psig

Dryer flow: 750 SCFM

$750 \text{ SCFM} \times 1.08 = 810 \text{ SCFM}$

The HC750 has a capacity of 810 SCFM operating at 120 psig



SPXFLOW®

SPX FLOW, Inc. reserves the right to incorporate our latest design and material changes without notice or obligation. Design features, materials of construction and dimensional data, as described in this bulletin, are provided for your information only and should not be relied upon unless confirmed in writing. Please contact your local sales representative for product availability in your region. The green “>” is a trademark of SPX FLOW, Inc.

For more information, visit www.spxflow.com.

P: (724) 745-1555 ▪ E: deltech.americas@spxflow.com | 4647 SW 40th Avenue ▪ Ocala, Florida 34474-5788 U.S.A.

DT_HC_US | VERSION 04/2022 | Copyright ©2022 SPX FLOW, Inc.